

Use

And

Care

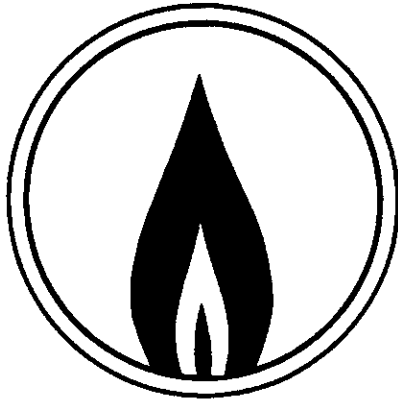

Instructions for your Gas Cooktop

CONTENTS

SAFETY INSTRUCTIONS	1-3	BURNER OPERATION	8
CONVENTIONAL COOKTOP	4-5	Lighting surface burners	8
Cooktop	4	Selecting flame size	8
Burner grates	4	CARE AND CLEANING CHART	9
Surface burners	4	MAINTENANCE	10
Griddle	5	Electrical connection	10
SEALED BURNER COOKTOP	6	Remove cooktop for cleaning	10
Cooktop	6	Hi-sim-warm valve adjustment	10
Burner grates	6	SERVICE	11
Dual purpose sealed burners	6	Before calling service chart	11
Igniters	6	How to obtain service	11
IGNITION SYSTEM	7	WARRANTY	14
Pilot ignition	7		
Pilotless ignition	7		

INSTALLER Please leave this manual with this appliance.

CONSUMER To save you time, energy and money, read and keep this manual for future reference.

MODEL IDENTIFICATION

Complete model and serial numbers are found on the rating plate. Conventional cooktop: Rating plate is located under the cooktop in the burner box area. Sealed burner cooktop: Rating plate is located on bottom-side of cooktop.

Model number: _____

Serial number: _____

Date of purchase: _____

SAFETY INSTRUCTIONS

WARNING: If the information in this manual is not followed exactly, a fire or explosion may result causing property damage, personal injury or death.

- Do not store or use gasoline or other flammable vapors and liquids in the vicinity of this or any other appliance.
- **WHAT TO DO IF YOU SMELL GAS**
 - Do not try to light any appliance.
 - Do not touch any electrical switch; do not use any phone in your building.
 - Immediately call your gas supplier from a neighbor's phone. Follow the gas supplier's instructions.
 - If you cannot reach your gas supplier, call the fire department.
- Installation and service must be performed by a qualified installer, service agency or the gas supplier.

Information in the Safety Instruction section covers all gas cooking appliances. You may find some information that does not pertain to your particular appliance. Please review this section before using your cooking appliance.

GENERAL

No cooking appliance should be used as a space heater. This instruction is based on safety considerations to prevent potential hazard to the consumer as well as damage to the appliance.

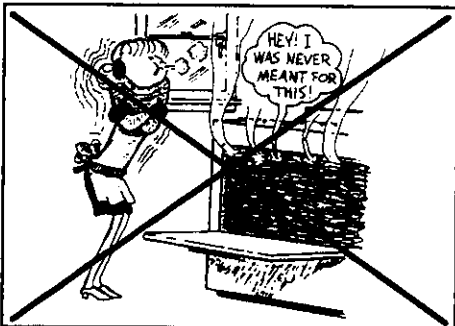

If appliance is installed near a window, proper precautions should be taken to prevent curtains from blowing over burners creating a FIRE HAZARD.

Keep area around appliance clear and free from combustible materials, gasoline, and other flammable vapors and materials.

Have the installer show you the location of the gas shut off valve and how to shut it off in an emergency.

If appliance is vented through the base of the backguard, never block oven vent or air intakes. Do not obstruct the flow of combustion and ventilation air. Restriction of air flow to the burner prevents proper performance.

Avoid touching oven vent area while oven is on and for several minutes after oven is turned off. Some parts of the vent and surrounding area become hot enough to cause burns.

Do not use cooktop or oven as a storage area for food or cooking utensils. This instruction is based on safety considerations to prevent potential hazard to user and to the appliance.

Misuse of appliance doors, such as stepping, leaning or sitting on the door, may result in possible tipping of the appliance or breakage of door and serious injuries.

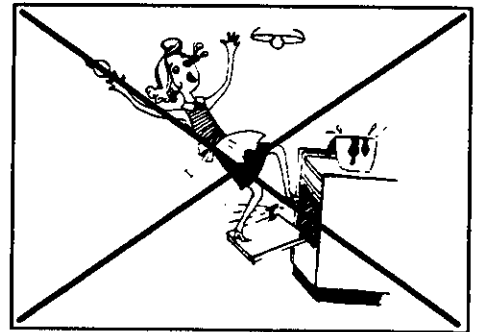

SAFETY INSTRUCTIONS

CHILD SAFETY

Do not leave children alone or unsupervised near the appliance when it is in use or is still hot. Children should never be allowed to sit or stand on any part of the appliance. Children must be taught that the appliance and utensils in it can be hot. Children should be taught that an appliance is not a toy. They should not be allowed to play with controls or other parts of the unit. Let hot utensils cool in a safe place, out of reach of small children.

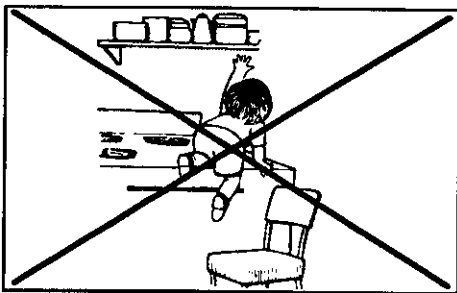

CAUTION: Do not store items of interest to children in cabinets above an appliance or on the backguard of a range. Children climbing on the appliance to reach items could be seriously injured. Do not use an appliance as a step stool to cabinets above.

ANTI-TIP DEVICE, if equipped

To reduce the risk of tipping of the appliance from unusual usage or by excessive loading of the oven door, the appliance must be secured by a properly installed anti-tip device. To check if device is installed properly: Use a flashlight and look underneath range to see that one of the rear leveling legs is engaged in the bracket slot. When removing appliance for cleaning, be sure anti-tip device is engaged when range is replaced. The anti-tip device secures the rear leveling leg to the floor, when properly engaged.

CLEANING

Turn off all controls and wait for appliance parts to cool before touching or cleaning them. Do not touch the burner grates or surrounding areas until they have had sufficient time to cool.

Touching a hot oven light bulb with a damp cloth could cause the bulb to break. Should the bulb break, disconnect power to the range before trying to remove the bulb to avoid electrical shock.

Clean appliance with caution. If a wet sponge or cloth is used to wipe spills on a hot cooking area, be careful to avoid steam burns. Some cleaners can produce noxious fumes if applied to a hot surface.

GREASE

Use extreme caution when moving the grease kettle or disposing of hot grease.

Hot grease is flammable. Avoid letting grease deposits collect around appliance, range hood, or vent fan. Do not leave container of grease around a cooking appliance. Always let quantities of hot fat used for deep fat frying cool before attempting to move or handle. In the event of a grease fire, **DO NOT** attempt to move pan. Cover pan with a lid to extinguish flame and turn surface burner off. Do not douse flame with water. Use a dry chemical or foam-type fire extinguisher, if available, or sprinkle heavily with baking soda.

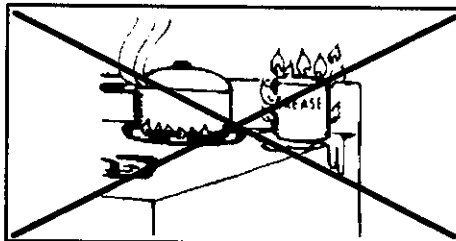

Spills or boilovers which contain grease should be cleaned up as soon as possible. If they are allowed to accumulate, they could create a FIRE HAZARD.

COOKING SAFETY

Always adjust surface burners flame so that it does not extend beyond the bottom of utensil. This instruction is based on safety considerations.

Never leave a surface cooking operation unattended especially when using a high heat setting. Boilovers cause smoking and greasy spillovers may ignite.

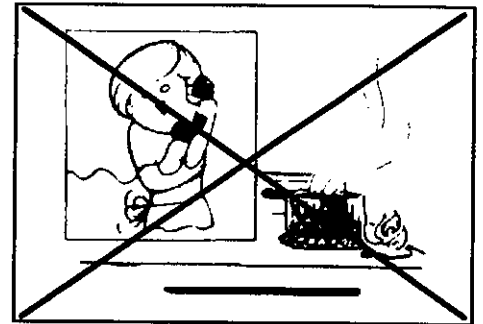

Be sure you know which knob controls which surface burner. Always make sure the correct burner is turned on and that the burner has ignited. When cooking is completed, turn burner off.

Use caution when wearing garments made of flammable material to avoid clothing fires. Loose fitting or long hanging-sleeved apparel should not be worn while cooking. Clothing may ignite or catch utensil handles.

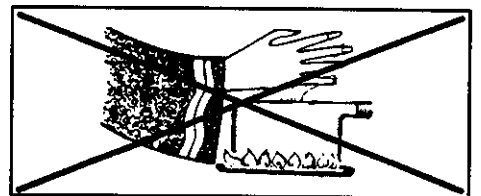

Never heat an unopened container on the surface burner or in the oven. Pressure build-up may cause container to burst resulting in serious personal injury or damage to the range.

Slide oven rack out to add or remove food, using dry, sturdy pot holders. Always avoid reaching into oven to place or remove food.

Use dry, sturdy pot holders. Damp pot holders may cause burns from steam. Dish towels or other substitutes should never be used as pot holders because they can trail across hot surface burners and ignite or get caught on range parts.

Use care when opening oven door. Let hot air or steam escape before removing or replacing food. Always place oven racks in the desired positions while oven is cool. If a rack must be moved while hot, be careful to avoid contact of pot holders with oven burner flame.

SAFETY INSTRUCTIONS

STORAGE ABOVE RANGE

To eliminate the hazard of reaching over hot surface burners, cabinet storage should not be provided directly above a unit. If such storage is provided, it should be limited to items which are used infrequently and which are safely stored in an area subjected to heat from an appliance. Temperatures in storage areas above the unit may be unsafe for some items, such as volatile liquids, cleaners or aerosol sprays.

UTENSIL SAFETY

Use only pans that have flat bottoms and handles that are easily grasped and stay cool. Avoid using unstable, warped, easily tipped or loose handled pans. Do not use pans if their handles twist and cannot be tightened. Pans that are heavy to move when filled with food may also be hazardous.

Always place a pan of food on a surface burner before turning on burner. Turn off burner before removing the pan.

Always turn pan handles to the side or back of appliance, not out into the room where they are easily hit or reached by small children. To minimize burns, ignition of flammable materials and spillage due to unintentional contact with the utensil, do not extend handles over adjacent surface burners.

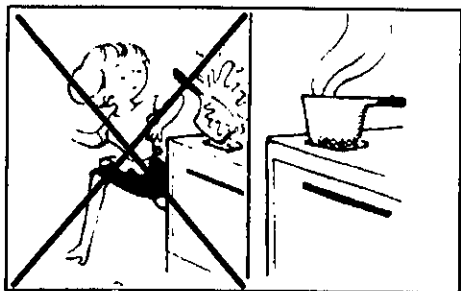

Be sure utensil is large enough to properly contain food and avoid boilovers. Pan size is particularly important in deep fat frying. Be sure pan will accommodate the volume of food that is to be

added as well as the bubble action of fat. Never leave a deep fat frying operation unattended.

Never let a pan boil dry as this could damage the utensil and the appliance.

ALUMINUM FOIL

Use aluminum foil ONLY as instructed in this book. Improper use of aluminum foil may cause damage to the oven, affect cooking results, and can also result in shock and/or fire hazards.

PLASTICS

Many plastics are vulnerable to heat. Keep plastics away from parts of the appliance that may become warm or hot.

PREPARED FOOD WARNING: Follow food manufacturer's instructions. If a plastic frozen food container and/or its film cover distorts, warps, or is otherwise damaged during cooking, immediately discard the food and its container. The food could be contaminated.

AEROSOL SPRAYS

Many aerosol-type spray cans are EXPLOSIVE when exposed to heat and may be highly flammable. Avoid their use or storage near an appliance.

SELF-CLEAN OVEN

Do not clean door gasket. The door gasket is essential for a good seal. Care should be taken not to rub, damage, or move the gasket. Do not use oven cleaners of any kind in or around any part of the self clean oven. Clean only parts listed in this booklet. Before self-cleaning the oven, remove broiler pan, oven racks, and other utensils, and wipe off excessive spillovers.

It is normal for the cooktop of the range to become hot during a self-clean cycle. Therefore, touching or lifting the cooktop during a clean cycle should be avoided.

IMPORTANT SAFETY NOTICE AND WARNING

The California Safe Drinking Water and Toxic Enforcement Act of 1986 (Proposition 65) requires the Governor of California to publish a list of substances known to the State of California to cause cancer or reproductive harm, and requires businesses to warn customers of potential exposures to such substances.

Users of this appliance are hereby warned that the burning of gas can result in low-level exposure to some of the listed substances, including benzene, formaldehyde and soot, due primarily to the incomplete combustion of natural gas or liquid petroleum (LP) fuels. Properly adjusted burners will minimize incomplete combustion. Exposure to these substances can also be minimized by properly venting the burners to the outdoors.

VENTILATING HOOD

To reduce the hazard of storage above a range, install a ventilating hood that projects at least 5 inches beyond the bottom edge of the cabinets. Clean hood frequently to prevent grease from accumulating on hood or its filter. Should a boilover or spillover result in an open flame, immediately turn off the hood's fan to avoid spreading the flame. After thoroughly extinguishing flame, the fan may be turned on to remove unpleasant odor or smoke.

IN CASE OF FIRE:

1. Turn off range controls.
2. Smother fire or flame with baking soda, dry chemical, or a foam-type extinguisher. Do not use water on grease fires.

CONVENTIONAL COOKTOP

COOKTOP

Cooktop featuring sealed burners is not removable and does not lift up. See pages 6 and 7.

The top can be completely removed or, if equipped with a metal support rod, can rest on the rod. Support rod is located across the front of the burner box.

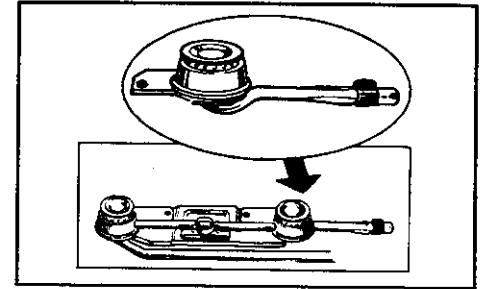
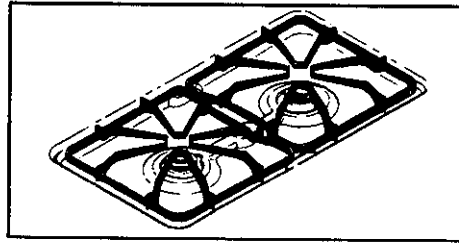

To remove cooktop: When cool, first remove grates and drip bowls, if equipped. Grasp two front burner wells and lift up.

BURNER GRATES

Burner grates must be properly positioned before cooking. Do not operate burners without a pan on the grate. The porcelain finish may chip without a pan to absorb the intense heat.

When reinstalling square grates, place indented sides together so straight sides are at front and rear.

CAUTION: Do not operate burner without a pan on the grate. The porcelain finish of the grate may chip without a pan to absorb the intense heat from the burner flame.

SURFACE BURNERS

Surface burners are secured in place during transportation with either a shipping screw or a spring clip. Once the cooktop is installed, these may be removed to allow quick and easy removal of the burner.

To remove: Remove or support cooktop. When cool, grasp burner head and tilt to release tab from slot near ignitor. Lift up and toward back of cooktop until air shutter end of burner releases from valve.

To replace: Insert air shutter end of burner over valve and lower into place. Replace cooktop. Turn on burner to be sure burner has been correctly replaced.

CONVENTIONAL COOKTOP

GRIDDLE

Before using the griddle for the first time, season it by lightly rubbing the surface with a small amount of unsalted shortening. To prevent damage to the finish, do not use metal utensils, a high flame setting or suddenly change temperatures, such as immersing hot griddle in water.

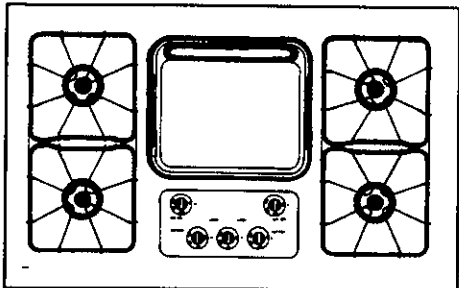

Remove griddle cover: (if equipped)

1. Press down on any corner.
2. Slide fingers under two sides of griddle cover and lift off. **DO NOT** pry off with any instrument or tool.

To use griddle:

1. Remove griddle cover **BEFORE** turning on griddle burner. Top cover must be removed whenever griddle burner is in use.
2. Be sure grease cup, located under griddle, is in place.
3. Position griddle correctly. For even cooking results, preheat griddle us-

ing a low flame setting for about 5 minutes or until the entire cooking surface is heated. Sprinkle a few drops of water over griddle. If properly heated, water will bead and dance. The water will sizzle and steam if griddle is not hot enough.

4. Never replace griddle cover until griddle has cooled completely.

To clean griddle:

When griddle is cool, remove and wash in hot soapy water; rinse and dry. Do not wash in the dishwasher. Detergents will completely remove the seasoning.

There is a grease pan located at the center rear of the griddle burner. This pan should be removed and cleaned as necessary.

SEALED BURNER COOKTOP

The cooktop and surface burners on this appliance are considerably different from a conventional gas cooktop. To ensure proper and efficient use of all features, please take a few minutes to read these instructions and become familiar with the operation of this appliance.

COOKTOP

The cooktop is designed with two contoured wells which contain spills until they can be wiped up. Unlike the standard gas appliance, **THIS COOKTOP DOES NOT LIFT-UP NOR IS IT REMOVABLE.** To prevent damage to the gas tubing or top, do not attempt to lift cooktop.

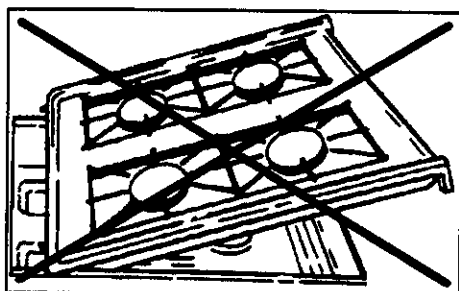

BURNER GRATES

Burner grates must be properly positioned before cooking. Do not operate burners without a pan on the grate. The porcelain finish may chip without a pan to absorb the intense heat.

When reinstalling square grates, place indented sides together so straight sides are at front and rear.

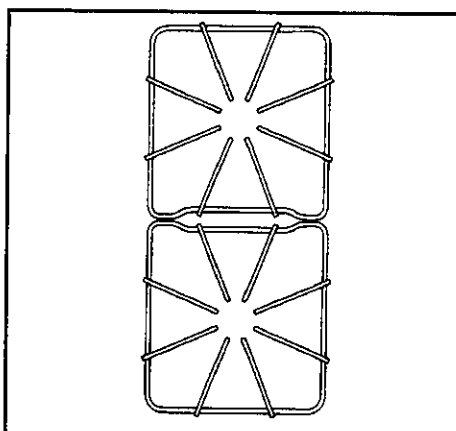

CAUTION: Do not operate sealed burner without a pan on the grate. The porcelain finish of the grate may chip without a pan to absorb the intense heat from the burner flame.

DUAL PURPOSE SEALED BURNERS*

The four sealed burners are secured to the cooktop and are **NOT** designed to be removed by the consumer.

Since the four burners are sealed into the cooktop, boilovers won't seep underneath to the burner box area. Thus, there are no hidden spills in the burner box area to clean.

IMPORTANT

Use of a drip bowl is not recommended with the sealed burner. If a drip bowl is used, it will have a negative effect on the proper operation of the burner. Your new cooktop has been specially designed so that it is not necessary to use a drip bowl.

Some models feature two special HI SPEED sealed burners. Use the HI SPEED burners to quickly bring water to

a boil and for large - pot cooking. See information on rating plate to determine if your appliance features the HIGH SPEED burners.

LOCATION OF BURNERS:

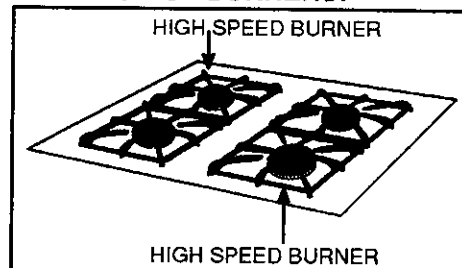

IGNITORS

All four ignitors will spark when any surface burner knob is turned to the LITE position.

Once burner lights, turn knob to the desired setting. The sparking will not stop until the knob is turned from the LITE position.

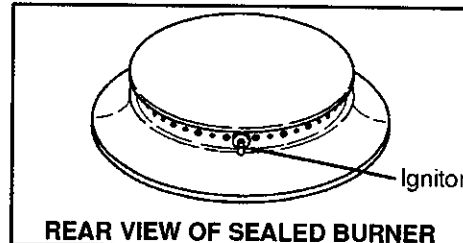

When cleaning around the surface burner, use care to prevent damage to the spark ignitor which is located at the back-side of each burner. If a cleaning cloth should catch the ignitor, it could damage or break it. If the ignitor is damaged or broken, the surface burner will not light.

*U.S. Patent Pending

IGNITION SYSTEM

IGNITION SYSTEM

Your cooktop is equipped with either pilot ignition or pilotless ignition.

Pilot ignition uses a standing pilot to light the burner.

Pilotless ignition uses a spark from the ignitor to light the burner.

Be sure all surface controls are set in the OFF position prior to supplying gas to the appliance.

PILOT IGNITION

When the cooktop is first installed, the pilots may be difficult to light due to air in the gas line. To bleed off air from the line, hold a lighted match next to the burner and turn knob on. When the burner lights, turn the knob off and proceed as directed below.

To light pilot: Remove or raise and support cooktop on metal rod, if equipped. Hold lighted match near the pilot ports.

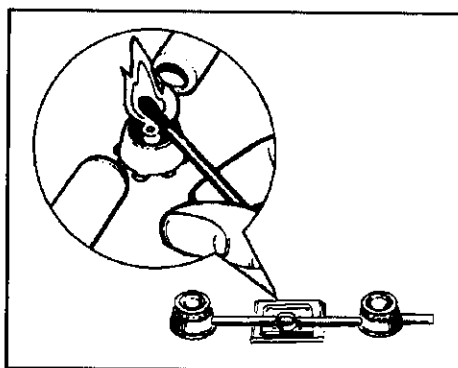

PILOTLESS IGNITION

Cooktops featuring pilotless ignition are equipped with ignitors that spark when any surface control is turned to the LITE position.

Once burner lights, turn knob to the desired setting. The sparking will not stop until the knob is turned from the LITE position.

To operate surface burner with pilotless ignition during a power failure:

1. Be sure all controls are in the OFF position.
2. Hold a lighted match to the desired surface burner head.
3. Turn knob to LITE. The burner will then light.
4. Adjust the flame to the desired level.

BURNER OPERATION

LIGHTING SURFACE BURNERS

1. Place utensil on burner grate.
2. Push in and turn knob to the LITE position.

On pilotless ignition models, a sparking sound will be heard and the burner will light. When one burner is turned on, all ignitors will spark.

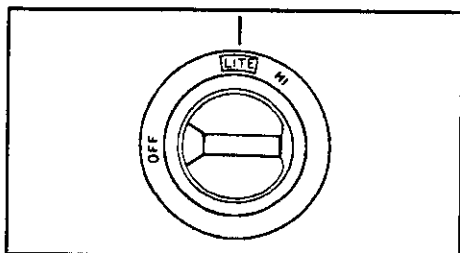

3. After the burner lights, turn knob to the desired flame size. NOTE: On pilotless ignition models, the ignitor will continue to spark until the knob is turned from the LITE position.

A properly adjusted burner with clean ports will light within a few seconds.

On natural gas, the flame will be blue with a deeper blue inner core; there should be no trace of yellow in the flame. A yellow flame indicates an improper mixture of air/gas. This wastes fuel, so have a serviceman adjust the mixture if a yellow flame occurs. On LP gas, some yellow tipping is acceptable. This is normal and adjustment is not necessary.

If flame should go out during a cooking operation, turn the burner off. IF GAS HAS ACCUMULATED AND A STRONG GAS ODOR IS DETECTED, WAIT 5 MINUTES FOR THE GAS ODOR TO DISAPPEAR BEFORE RELIGHTING BURNER.

You may hear a "popping" sound on some types of gas when the surface burner is turned off. This is a normal operating sound of the burner.

SELECTING FLAME SIZE

If a knob is turned very quickly from HIGH to WARM setting, the flame may go out, particularly if burner is cold. If this occurs, turn the knob to the OFF position. Wait several seconds, then light again.

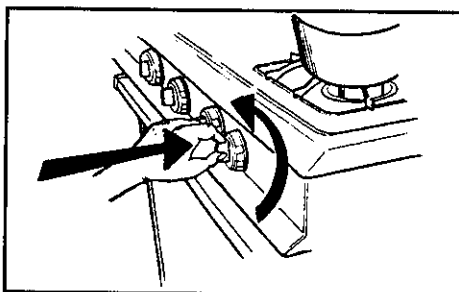

Flame should be adjusted so it does not extend beyond the edge of cooking utensil. This is for personal safety and to prevent damage to cabinets above cooktop.

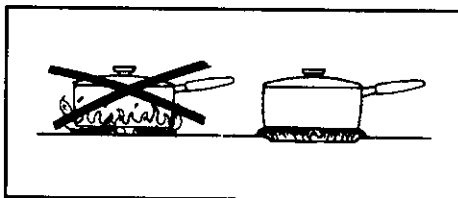

HIGH

Use HIGH to quickly bring foods to a boil or to begin a cooking operation. Reduce to a lower setting to continue cooking. Never leave food unattended when using a HIGH flame setting.

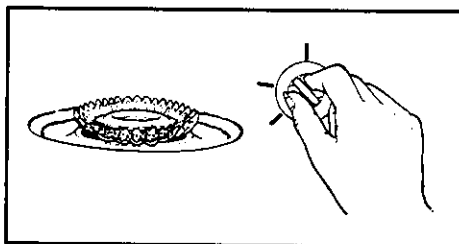

SIMMER, if equipped

Use SIMMER (medium) to continue a cooking operation. Food will not cook any faster when a higher flame setting is used than needed to maintain a gentle boil.

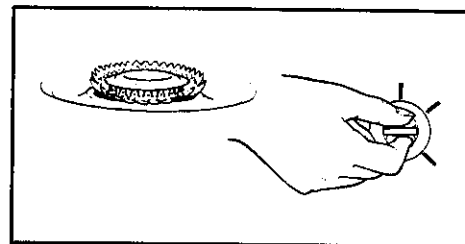

WARM

Use WARM (low) to simmer. Some cooking may take place if the utensil is covered.

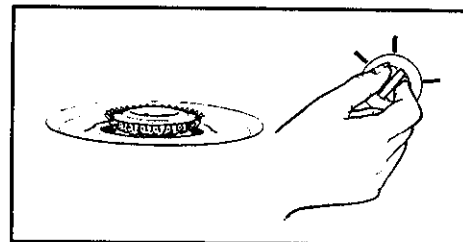

To obtain a lower flame size, turn knob back toward the OFF position until the desired flame size is reached. The lowest flame setting is located between the LITE and OFF position. This is not a preset position.

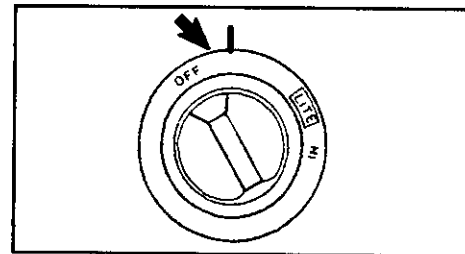

CARE AND CLEANING

PARTS	CLEANING AGENTS	DIRECTIONS <i>Be sure all parts are cool before cleaning.</i> <i>Be sure all parts are properly replaced after cleaning.</i>
Burner box (conventional surface burner only)	Soap & water.	Burner box, located under cooktop, should be cleaned frequently to remove spillovers. If soil is not removed and is allowed to accumulate, it may damage the finish. To clean, remove surface burners and clean with soap and water, rinse and dry.
Chrome drip bowls (conventional surface burner only)	Soap & water. Paste of baking soda and water. Plastic scouring pad.	Clean bowls after each use with soap and water. Remove stubborn stains with baking soda paste and plastic scouring pad. To prevent scratching the finish, do not use abrasive cleaning agents. Rinse, dry and replace. NOTE: Rings can be permanently discolored if exposed to excessive heat or if soil is allowed to bake on.
Control knobs	Mild detergent & water.	To remove knobs for cleaning, gently pull up. Wash in mild detergent and water. Do not use abrasive cleaning agents. They will scratch finish and remove markings. Rinse, dry and replace. Turn on each burner to see if knobs have been replaced correctly.
Cooktop, glass	Soap & water. Paste of baking soda & water. Window cleaning fluid or ammonia.	The tempered glass cooktop will withstand temperature changes while cooking. Although impact resistant, treat this glass cooktop with the same care you would any glass material. Clean glass cooktop after surface is cool. Wash with cloth wrung out in soapy water. Do not use abrasive materials such as scouring pads, steel wool or powdered cleaning agents. They will damage glass. Rinse with clear water and dry. To prevent staining of glass, never use excessive amounts of water which may seep under or behind glass. Only use cleaners that are recommended for glass surfaces.
Cooktop, porcelain	Mild soap & water. Paste of baking soda & water.	Porcelain enamel is glass fused on metal. It may crack or chip with misuse. Clean with soap and water when parts are cool. All spillovers, especially acid spillovers, should be wiped up immediately with a dry cloth. When surface is cool, clean with warm soapy water. NEVER WIPE OFF A WARM OR HOT ENAMEL SURFACE WITH A DAMP CLOTH. THIS MAY CAUSE CRACKING AND CHIPPING. Never use abrasive or caustic cleaning agents on exterior finish of range.
Grates	Detergent & water. Soap filled scouring pad.	Grates are made of porcelain-coated steel. They can be cleaned at the sink with detergent and water or in the dishwasher. Clean stubborn soil with soap filled scouring pad.
Surface burners, conventional	Soap & water. Paste of baking soda and water. Plastic scouring pad such as Tuffy®.	Clean as necessary with warm soapy water. Remove stubborn soil by scouring with a non-abrasive plastic scouring pad and a paste of baking soda and water. Clean ports with a straight pin. Do not enlarge or distort the ports. Do not use a wooden toothpick. It may break off and clog port. DO NOT CLEAN BURNERS WITH THE FOLLOWING caustic cleaners: steel wool, abrasive cleaning agents, dishwasher detergent, or metal polishes. These will damage finish. Burners can be dried in the oven set at 140°F. CAUTION: Burner and burner tube must be dry before use.
Surface burners, sealed	Soap & water. Paste of baking soda and water. Plastic scouring pad such as Tuffy®.	Clean as necessary with warm soapy water. Remove stubborn soil by scouring with a non-abrasive plastic scouring pad and a paste of baking soda and water. Clean ports with a straight pin. Do not enlarge or distort the ports. Do not use a wooden toothpick. It may break off and clog port.

MAINTENANCE

ELECTRICAL CONNECTION

Appliances which require electrical power are equipped with a three-prong grounding plug which must be plugged directly into a properly grounded three-hole 120 volt electrical outlet.

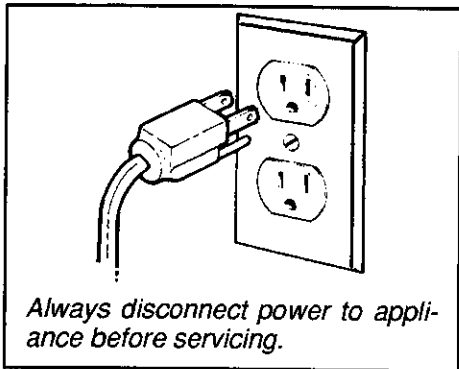

If an ungrounded, two-hole or other type electrical outlet is encountered, IT IS THE PERSONAL RESPONSIBILITY OF THE APPLIANCE OWNER TO HAVE RECEPTACLE REPLACED WITH A PROPERLY GROUNDED THREE HOLE ELECTRICAL OUTLET. The three-prong grounding plug is provided for protection against shock hazards. DO NOT CUT OR REMOVE THE THIRD GROUNDING PRONG FROM THE POWER CORD PLUG.

HOW TO REMOVE COOKTOP FOR CLEANING AND SERVICING

When necessary, follow these procedures to remove appliance for cleaning or servicing:

1. Shut-off gas supply to appliance.
2. Disconnect electrical supply to appliance.
3. Disconnect gas supply tubing to appliance.
4. Remove screws that secure appliance to cabinet. Remove appliance from cabinet.
5. Reverse procedure to reinstall. If gas line has been disconnected, check for gas leaks after reconnection. (See Installation instructions for gas leak test method.) Note: A trained serviceman should make the gas installation, disconnection, and re-connection of gas supply to the appliance.

HI-SIM-WARM VALVE ADJUSTMENT

(if equipped)

The WARM setting should produce a stable flame when turning the knob from HI to WARM. On conventional surface burners, the flame should be 1/8 inch or lower and must be stable on all ports on WARM setting. For sealed burners, the flame should extend to the outer edge of the lip on the burner cap on the WARM setting.

If flame adjustment is needed, adjust **ONLY** on the WARM setting.

To adjust: Operate burner on HI for about 5 minutes to preheat burner cap. Turn knob back to WARM; remove knob, and insert a small screwdriver into the center of the valve stem. Adjust flame size by turning adjustment screw in either direction. Flame must be of sufficient size to be stable on all burner ports. NEVER adjust flame size at the HI or SIMMER setting.

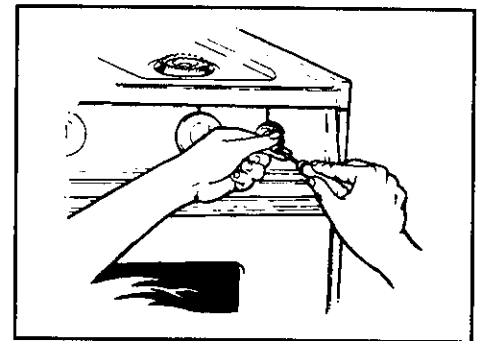

SERVICE

BEFORE CALLING A SERVICE TECHNICIAN, CHECK THE FOLLOWING:

PROBLEM	CAUSE	CORRECTION
1. Surface burner fails to light	a. power supply not connected (pilotless ignition). b. clogged burner port(s). c. sealed burner incorrectly installed. d. sealed burner model: electrode or ignitor has broken. e. pilot models: pilot is not lit.	a. connect power, check circuit breaker or fuse box. b. clean ports with straight pin. c. see page 8. d. call serviceman to replace. e. light pilot, see page 4.
2. Burner flame uneven	a. clogged burner port(s). b. burner not properly positioned.	a. clean ports with straight pin. b. see page 5 or 8 to correctly replace burner or burner cap.
3. Surface burner flame <ul style="list-style-type: none"> • lifts off port • yellow in color 	a. air/gas mixture not proper.	a. call serviceman to adjust burner primary air.
4. Popping sound heard when burner extinguishes.	This is a normal sound that occurs with some types of gas when a hot burner is turned off. The popping sound is not a safety hazard and will not damage the appliance.	

SERVICING

Electrical supply, if equipped, must be disconnected from the wall outlet before servicing appliance. Do not repair or replace any part of your range unless specifically recommended in this manual. All other servicing should be referred to a qualified technician.

HOW TO OBTAIN SERVICE

When your appliance requires service or replacement parts, contact your Dealer or Authorized Servicer. Use only genuine factory or Maycor parts if replacement parts are necessary. Consult the Yellow Pages in your telephone directory under appliance for the service center nearest you. Be sure to include your name, address, and phone num-

ber, along with the model and serial numbers of the appliance. (See front cover for location of your model and serial numbers.)

If you are unable to obtain service, write to us. Our address is found on the rating plate. See front cover for location of rating plate.

If you are not satisfied with the local response to your service requirements, call or write MAYCOR Appliance Parts and Service Company, 240 Edwards Street, S.E., Cleveland, TN 37311, (615) 472-3500. Include or have available the complete model and serial numbers of the appliance, the name and address of the dealer from whom you purchased the appliance, the date of

purchase and details concerning your problem.

If you did not receive satisfactory service through your servicer or Maycor you may contact the Major Appliance Consumer Action Panel by letter including your name, address, and telephone number, as well as the model and serial numbers of the appliance.

Major Appliance Consumer Action Panel
 20 North Wacker Drive
 Chicago, IL 60606

MACAP (Major Appliance Consumer Action Panel) is an independent agency sponsored by three trade associations as a court of appeals on consumer complaints which have not been resolved satisfactorily within a reasonable period of time.

FULL ONE-YEAR WARRANTY

DOMESTIC GAS OR ELECTRIC RANGE

Maycor Appliance Parts & Service Company will repair or replace, without charge, any part of your product which has a defect in material or workmanship during the first year after the date of the original installation. This warranty extends to any owner during the one-year warranty period.

LIMITED 5 YEAR WARRANTY

On electric ranges equipped with solid disc or smoothtop heating elements, and on gas ranges with sealed burners, for an additional 4 year period beyond the first year of the general coverage of this warranty, Maycor will replace any of the solid disc or smoothtop heating elements, or sealed burners which fail to heat as a result of defective workmanship or material. Additionally, Maycor will replace any smoothtop cooking surface which cracks or breaks during normal household cooking. These parts must be installed by a qualified person. Any labor charge required for replacement is not covered by this warranty.

HOW TO OBTAIN SERVICE

To obtain the repair or replacement of a defective part under these warranties, you should contact the dealer from whom you purchased the appliance or a servicer he designates.

WHAT IS NOT COVERED BY THESE WARRANTIES

1. Conditions and damage resulting from improper installation, delivery, unauthorized repair, modification, or damage not attributable to a defect in material or workmanship.
2. Conditions resulting from damage, such as: (1) improper maintenance, (b) misuse, abuse, accident, or (c) incorrect electrical current or voltage.
3. Warranties are void if the original serial number has been removed, altered, or cannot be readily determined.
4. Light bulbs.
5. Any product used for other than normal household use. It does not extend to products purchased for commercial or industrial use.
6. Any expense incurred for service calls to correct installation errors or to instruct you on how to use the products.
7. CONSEQUENTIAL OR INCIDENTAL DAMAGES SUSTAINED BY ANY PERSON AS A RESULT OF ANY BREACH OF THESE WARRANTIES OR ANY IMPLIED WARRANTY. Some states do not allow the exclusion or limitation of consequential or incidental damages, so the above exclusion may not apply to you.

ADDITIONAL HELP

If you are not satisfied with the local response to your service requirements and wish to contact Maycor, please address your letter to the Customer Relations Department, Maycor Parts & Service Company, 240 Edwards Street, S.E., Cleveland, TN 37311 or call (615) 472-3500. To save time, your letter should include the complete model and serial numbers of the warranted appliance, the name and address of the dealer from whom you purchased the appliance, the date of purchase and details concerning your problem.

These warranties are the only written or expressed warranties given by Maycor. No one is authorized to increase, alter, or enlarge Maycor's responsibilities or obligations under these warranties. These warranties give you specific legal rights, and you may also have other rights which vary from state to state.

8109P059-60
(6/91)